

INSTALLATION INSTRUCTIONS

20, 200, 240, 241, 242, 400B, & 450B SERIES

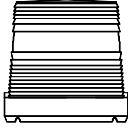

20ZI & 200Z
SERIES



21ZI & 201Z
SERIES

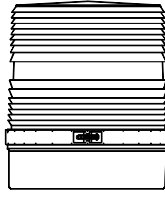

200S
SERIES

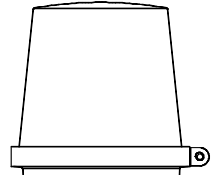

20FI, 20RH, 20RI, 200J,
& 200U SERIES

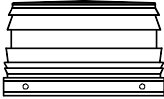

241S SERIES

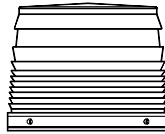

240S/242S SERIES

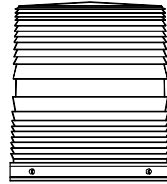

240C/242C,
240A/242A SERIES

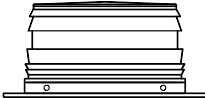

241SF SERIES

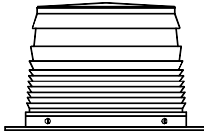

240SF/242SF
SERIES, 240ZF

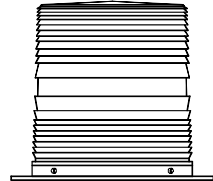

240CF/242CF,
240A/242A SERIES

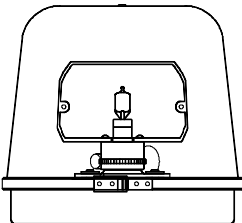

450BH SERIES

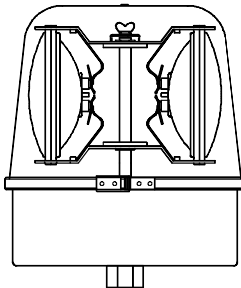

400B SERIES

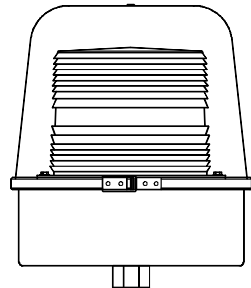

200B SERIES

STAR
WARNING
SYSTEMS

Star Headlight & Lantern Co., Inc.

455 Rochester Street
Avon, NY 14414



Phone: 585-226-9500
Toll Free Fax: 888-478-2797

www.star1889.com

Signal
VEHICLE PRODUCTS

INSTALLATION INSTRUCTIONS

IMPORTANT: Please read all of the following instructions before installing your new warning light.

1. **CAUTION:** All of our DC powered warning lights are polarity sensitive. These lights are polarity protected *only if the appropriate fuse* is used. All wires connected to the positive terminal of the battery should be fused at the battery for their rated load. **Testing the light before this fuse is properly installed will void the warranty on the light.**
2. Your new warning light comes complete with a foam mounting gasket, mounting screws, lock washers, and well nuts.
3. For any models utilizing a **flange mount base**, please skip to Step 6.
4. The 20 Series, 200 Series, and the 240 Series Star warning lights come equipped with a combination base, allowing the light to be mounted on either a 1/2" NPT conduit pipe or permanently mounted. For NPT pipe, mount the light using the threaded entrance hole in the base of the light, then skip to Step 12. For the permanent mount, proceed to Step 5.
5. Carefully remove either the clamp ring or the three or four screws near the base of the lens and lift off the lens. Examine the inside of the base and use a punch or drill to remove the knock-outs present.
6. Remove the foam gasket from the shipping box. Each gasket comes furnished with three or four holes. (NOTE: You might have to stretch the gasket to find the location of the holes.) Place the gasket in the exact position the light is to be mounted.
7. Using the gasket as a template, mark the holes on the mounting surface. Take care to ensure that the gasket does not move while you are marking each of the holes.
8. Remove the gasket and drill a 3/8" hole in the **outer locations only**.
CAUTION: Take care not to drill through the headliner of the vehicle below.
9. Push the enclosed rubber well nuts through the holes until the bottom side of the wider lip rests on the surface of the vehicle.
10. *If you are mounting the light on a vehicle* and plan to wire it through the roof of the vehicle remove the headliner from the inside of the vehicle. Drill a 3/8" hole in the center marked location. Place the light on the surface of the vehicle, routing the wires through the hole.
11. To secure the light to your mounting surface, align the holes with the well nuts. Install the two screws through the base, into the well nuts, and tighten until snug.
12. The black or white wire is the ground lead and should be connected to a good chassis ground.
13. Connect the red wire to the positive side of the power through either a single-pole, two position switch for normal operation or a two-switch switch-panel for HI/LO operation (Available only on models with three wires), and a 5 Amp fuse, *checking the label on the warning light for proper voltage*. If your light has only two wires then you are finished and may skip the remaining steps.
14. If your light has three wires (red, black, and purple) you need to decide how you would like the light to operate:
 - To utilize the HI/LO option :** Skip to Step 15.
 - For low power only:** Leave the purple wire unconnected and place a wirenut over the end. Skip the remaining step.
 - For high power only:** Connect the purple wire to the good chassis ground
15. *If you intend to make use of the HI/LO option*, refer to the wiring diagram on the following page for proper connections using a two-switch switch panel available from Star.

If you have any questions concerning this or any other Star product, please contact our Customer Service Department at (585) 226-9787.

SPECIAL 242 SERIES FEATURES

The **NEW** 242 Series strobe lights have a number of new and exciting features :

1. **LED Diagnostic Indicator** : The 242 contains an LED designed to flash when the strobe tube should be flashing. If a strobe light is not working, troubleshooting becomes a breeze with this new LED. Simply examine the circuit when power is applied to it. If the strobe tube is not flashing, but the LED is flashing, you have a bad strobe tube. If the LED is not flashing, the circuit is either not receiving the proper voltage, or the circuit has failed.
2. **Photocell** : The 242 has a built-in photocell which will automatically switch the light to low power during "night" (or low light) conditions when such a high intensity is not required.
3. **Pattern Select Jumper** : The 242 lights have a jumper on the circuit allowing the end user to select the desired flash pattern. Placing the jumper on pins 1 and 2 will elicit a quadflash pattern, and placing the jumper on 2 and 3 will produce a random flash pattern.

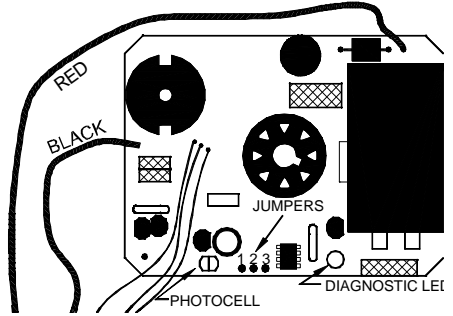

WIRING DIAGRAM FOR STAR STROBE MODELS WITH HI/LO OPTION (Red, Black, and Purple wires present)

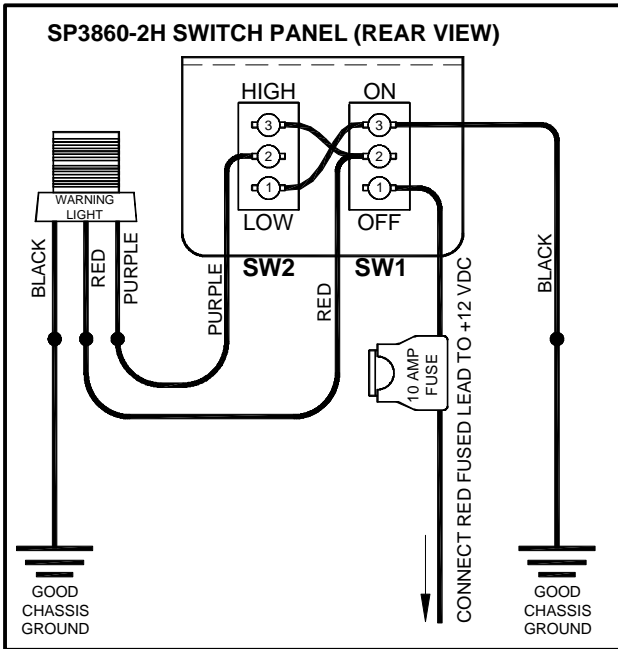

A two-switch switch-panel is required to utilize the HI/LO power option.
Make your connections as illustrated above.

ONE YEAR LIMITED WARRANTY

The manufacturer warrants each new product, under normal use, against factory defects in material and workmanship for one year after the date of purchase. The owner will be responsible for returning to the Service Center any defective item(s) with the transportation costs prepaid. The manufacturer will, without charge, **repair or replace at its option**, products, or part(s), which its inspection determines to be defective. Repaired or replacement item(s) will be returned to the purchaser with transportation costs prepaid from the service point. A copy of the purchaser's receipt must be returned with the defective item(s) in order to qualify for the warranty coverage.

Exclusions from this warranty include, but are not limited to, bulbs, strobe tubes, domes, and/or the finish. This warranty shall not apply to any light, which has been altered, such that in the manufacturer's judgment, the performance or reliability has been affected, or if any damage has resulted from abnormal use or service. This warranty does not apply to defect or damage occurring as a result of disaster, accident, abuse, misuse, lightning, power surges, or failure to follow instructions in any enclosed manuals. Any damage or defects occurring as a result of any unauthorized service or repairs by unauthorized persons shall be excluded from this warranty.

There are no warranties expressed or implied (including any warranty of merchantability or fitness), which extend this warranty period. **The loss of use of the product, loss of time, inconvenience, commercial loss or consequential damages, including costs of any labor, are not covered.** The manufacturer reserves the right to change the design of the product without assuming any obligation to modify any product previously manufactured.

This warranty gives you specific legal rights. You might also have additional rights which may vary from state to state. Some states do not allow limitations on how long an implied warranty lasts. Some states do not allow the exclusion or limitation of incidental or consequential damages. Therefore, the above limitation(s) or

If you have any questions concerning this or any other Star product, please contact our **Customer Service Department** at (585) 226-9787.

If a product must be returned for any reason, please contact our Customer Service Department to obtain a Returned Goods Authorization number (RGA #) before you ship the product to Star. Please write the RGA # clearly on the package near the mailing label.



Star Headlight & Lantern Co., Inc.

455 Rochester Street
Avon, NY 14414



Phone: 585-226-9500
Toll Free Fax: 888-478-2797



www.star1889.com