



INTERCEPTOR

LIGHTBARS

Owner's Manual & Installation



Made In USA

STAR
WARNING
SYSTEMS

Star Headlight & Lantern Co., Inc.

455 Rochester Street
Avon, NY 14414

www.star1889.com



Phone: 585-226-9500
Fax: 888-478-2797

www.star1889.com

Signal.
VEHICLE PRODUCTS

This page intentionally left blank.

Table of Contents

WARNINGS	2
MOUNTING BRACKET PARTS LIST	2
MOUNTING INSTRUCTIONS	3-7
Bracket Installation	3-4
Hook Mounting	5
Direct Mounting	6-7
WIRING INSTRUCTIONS	8-11
Wire Usage Table	8
Remote Strobe Power Supply Connections	9-10
Direct Wiring Guide	10-11
Dome Removal	10
PARTS	11
HOOK MOUNTS	12-13
Diagram	12
Application Chart	13
SWITCHES	14
TROUBLESHOOTING	15-17
WARRANTY	18
SERVICE	18

NOTICE

Due to continuous product improvements, we must reserve the right to change any specifications and information, contained in this manual at any time without notice. Star Headlight & Lantern Co., Inc. makes no warranty of any kind with regard to this manual, including, but not limited to, the implied warranties of merchantability and fitness for a particular purpose. Star Headlight & Lantern Co., Inc. shall not be liable for errors contained herein or for incidental or consequential damages in connection with the furnishing, performance, or use of this manual.



These lightbars contain one or more of the following light sources: Strobe Lights, Halogen Lamps, and/or High Intensity LED Lamps. **DO NOT** stare directly into any of these light sources as temporary blindness and/or permanent eye damage may occur.



PLEASE NOTE: THE DIRECT MOUNT IS THE STANDARD MOUNT INCLUDED WITH THE LIGHTBAR. BE SURE THAT YOU HAVE OPENED BOTH ENDS OF THE BOX WHEN LOOKING FOR THE DIRECT MOUNTS. THE HOOK MOUNTS MUST BE USED ON ALL POLICE AND/OR OTHER EMERGENCY VEHICLES!!! THE HOOK MOUNTS ARE OPTIONAL. THEY ARE NOT INCLUDED WITH EACH LIGHTBAR. THEY MUST BE ORDERED SEPARATELY. SEE PAGES 12-13 FOR A COMPLETE LIST OF AVAILABLE MOUNTS AND KNOWN VEHICLE APPLICATIONS.



It is the sole responsibility of the owner to ensure the lightbar is mounted securely. Check your light every time you enter the vehicle to ensure that it is mounted securely. The manufacturer assumes no responsibility for the secure mounting of this light.

The following mounting instructions describe the standard, most common way to mount this light. This method may or may not apply to your vehicle. Because vehicles can vary widely in their design, it may be necessary to configure the brackets differently than described. Some applications may require you to design your own custom brackets. The installer assumes all responsibility for the integrity of the installation. **It is the sole responsibility of the owner to ensure the lightbar is secure.**

MOUNTING BRACKET PARTS LIST

	QTY	Part #	Description
A	4	P30056-22	1" Bolt (1/4"-20)
B	4	P920-37	Molded Rubber Foot w/Metal Washer Insert
C	4	P30150-76-1*	Adjusting Cup
D	4	P30096-5	1/4"-20 Lock Nut w/Nylon Insert
E	2	P30150-76	Plastic Mounting Bracket
F	4	P30053-19	Allen Head Screw
G	8	P30057-4	5/16" x 1" Carriage Bolt
H	12	P30077-1	5/16" Flat Washer
I	8	P30077-2	5/16" Lock Washer
J	8	P30097-1	5/16"-18 Hex Nut
K	2	30258-1P	Tinnerman Clip w/Retaining Plate
L	4	P30057-14	5/16"-18 x 3" Carriage Bolt
M	4	P30097-4	5/16"-18 Lock Nut w/Nylon Insert

Mounting Instructions

Please review this entire instruction sheet prior to mounting your lightbar.

Installation

1. The first step to mounting your lightbar is to determine if you are going to direct mount it (bolt it through the roof or other surface) or if you are going to use a hook mount.



THE HOOK MOUNTS MUST BE USED ON ALL POLICE AND/OR OTHER EMERGENCY VEHICLES!!!

Once you have decided, follow the appropriate instructions.

- 2a. If you are going to **Direct Mount** your lightbar (bolt it through the roof of the vehicle) be sure that the Tinnerman Clip (K) is removed from the Mounting Brackets (E).

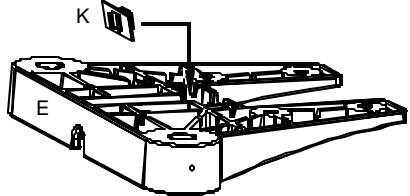

- 2b. If you are going to use a **Hook Mount** be sure that a Tinnerman Clip (K) is installed in each bracket. Make sure that the clip is installed in the correct slot and that the nut is towards the inside of the bar. (See the diagram to the right.)
Please Note: The Tinnerman Clip sits loosely in the mounting bracket. It is held in place only when the hook mount is attached and tightened down.

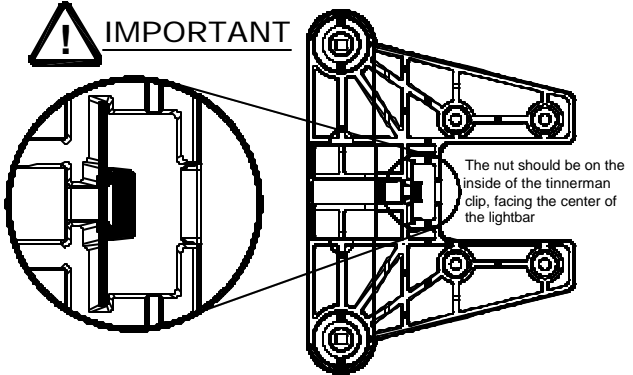

3. Attach the molded rubber feet (B) to the adjusting cups (C) using the hex head bolts (A) and lock nuts (D). Tighten the nut just enough to keep the bolt and nut from rattling. The rubber foot should still be able to "pivot" slightly on the cup. This will allow the rubber foot to conform to the slope of your roof. Repeat this for all four feet.

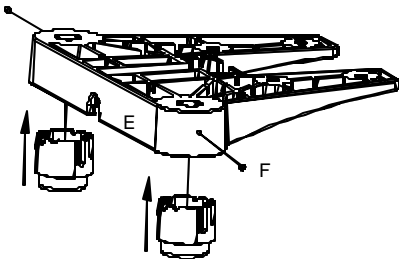

4. Once the rubber feet are attached to the cups, insert them into the mounting brackets (E).

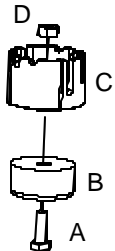

5. There are grooves in the top of each cup (C) that allow the feet to be adjusted to different heights.

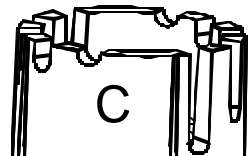

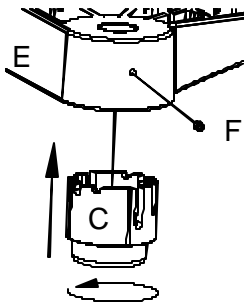

6. Rotate the cup so that it is at its highest setting. Tighten the Allen head screws (F) to hold all four cups in place. **Do not over-tighten any of the Allen head screws!**

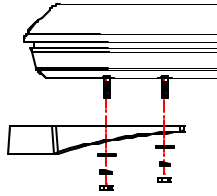
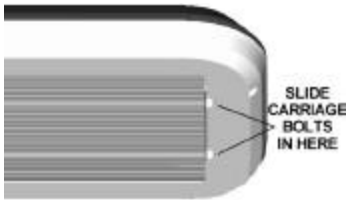

7. Install the mounting legs on the lightbar by sliding the heads of the eight 1" carriage bolts (G) into the channels running underneath the lightbar (four into each channel). Use four of the carriage bolts for each mounting bracket.

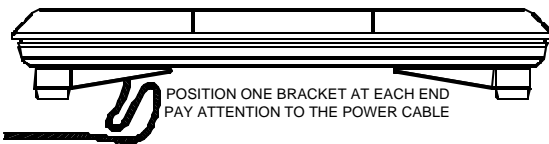

8. Position one bracket at each end of the lightbar. Be aware of the power cable exiting the lightbar when choosing the location of these brackets.

9. After the bracket has been placed on the four carriage bolts, install one flat washer (H), one lock washer (I), and one hex-nut (J) on each carriage bolt. Tighten hex nuts until snug, but loose enough that the mounting bracket can still slide for accurate pre-positioning.

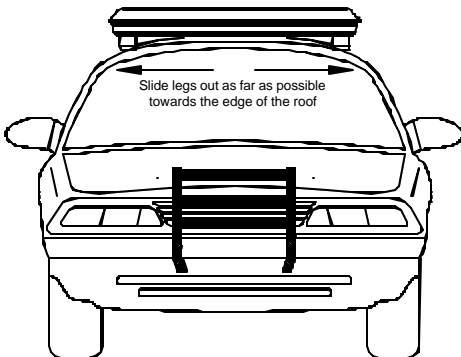
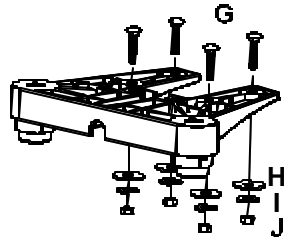

10. Place the lightbar on the vehicle roof and locate it in a position which is level front-to-back, and is centered side to side. Slide the brackets outward so that the rubber feet are as close to the edge of the roof as possible.



THE HOOK MOUNTS MUST BE USED ON ALL POLICE AND/OR OTHER EMERGENCY VEHICLES!!!

For direct mounting (bolting through the roof or other surface), go to the *Direct Mount* section. For hook mounting, proceed below.

Hook Mounting

THE HOOK MOUNTS ARE OPTIONAL. THEY ARE NOT INCLUDED WITH EACH LIGHTBAR. THEY MUST BE ORDERED SEPARATELY. SEE PAGES 12-13 FOR A COMPLETE LIST OF AVAILABLE MOUNTS AND KNOWN VEHICLE APPLICATIONS.

1. Once the lightbar is in the position where you want it mounted, you may set the bar to the desired height. Slightly loosen the Allen head screws (F) holding each foot in place. Lift each corner of the lightbar and rotate each individual foot until the lightbar is at the desired height. There are five different height settings for each leg. Repeat this for all four feet.



2. After you have adjusted each of the four feet to the desired height, check to see that the lightbar is level both side-to-side and front-to-back then tighten the Allen head screws. **Do not over-tighten any of the Allen head screws!**

3. Attach the optional hook mount to each bracket using the bolt provided with the mounts. Slip the bolt through the hole in the hook mount and screw it into the Timmerman Clip (K).

Please Note: For some applications, the bolt we provide may not be long enough. If the mounting brackets are fully extended and the hook mounts still will not reach the edge of the vehicle, you may use a longer 5/16" bolt obtained locally.

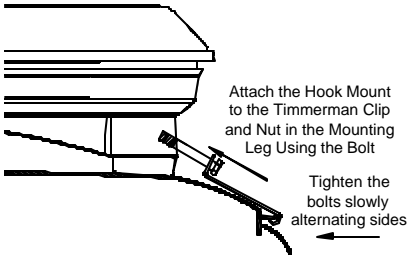
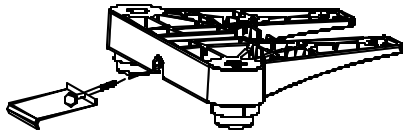
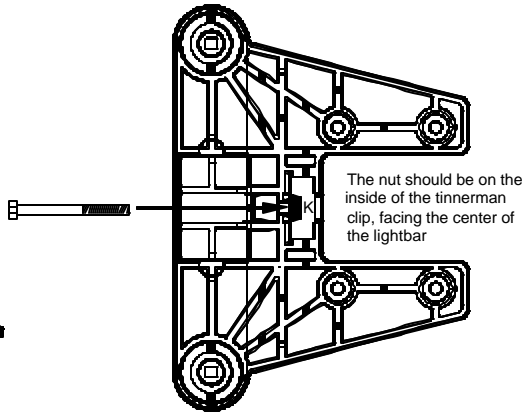

4. If using a Gutter Hook, tighten the bolt on one mounting bracket until the hook is just under the gutter. Repeat this on the other side. Then alternate sides, tightening each bolt approximately 1/2 turn until the mount is secure. **Do not over-tighten either mount!** It is not necessary to dimple the roof in order to achieve a secure, stable mount.

5. If you are installing a gutterless hook, tighten the bolt until the gutterless hook lip just touches the inside lip of door jamb. Drill two holes and install the two sheet metal screws through the enclosed rubber washers to secure the gutterless hook on the inside lip of the door jamb. Repeat this for the other side of the bar. Then alternate sides, tightening each bolt approximately 1/2 turn until the mount is secure.

Do not over-tighten either mount! It is not necessary to dimple the roof in order to achieve a secure, stable mount.

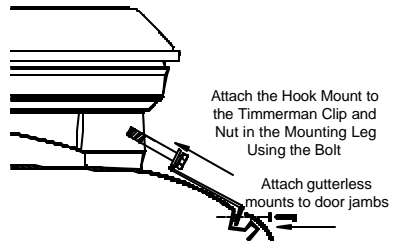

6. The mounting is complete and you may wire your lightbar.



THE HOOK MOUNTS MUST BE USED ON ALL POLICE AND/OR OTHER EMERGENCY VEHICLES!!!

Direct Mounting

PLEASE NOTE: THE DIRECT MOUNT IS THE STANDARD MOUNT INCLUDED WITH THE LIGHTBAR. BE SURE THAT YOU HAVE OPENED BOTH ENDS OF THE BOX WHEN LOOKING FOR THE DIRECT MOUNTS.

THE HOOK MOUNTS ARE OPTIONAL. THEY ARE NOT INCLUDED WITH EACH LIGHTBAR. THEY MUST BE ORDERED SEPARATELY. SEE PAGES 12-13 FOR A COMPLETE LIST OF AVAILABLE MOUNTS AND KNOWN VEHICLE APPLICATIONS.

1. Once the lightbar is in the correct position, level front to back and centered side to side, and the mounting brackets are slid into position as close to the edge of the vehicle as possible, mark the location of the four feet. Check that the distance from the front windshield to the front holes (X1) is the same as the distance from the front windshield to the other front hole (X2).
2. Measure the distance between the two marked spots (Y1) and note it. Check that the marked spots for the rear holes are 10" back from the two front marked spots. Ensure the distance between them (Y2) is identical to the distance between the two front locations (Y1).
3. Confirm your marked spots are square by measuring the diagonals (Z1 & Z2). They should be equal.
4. Remove the lightbar, and drill four 11/32" holes in the roof of the vehicle.
CAUTION: Check the underside of your roof to ensure you do not damage anything beneath the holes. Remove any burrs.
5. Slide each of the mounting brackets outward allowing you access to the bolts (A) and nuts (D) that hold the rubber feet (B) to the cups (C).

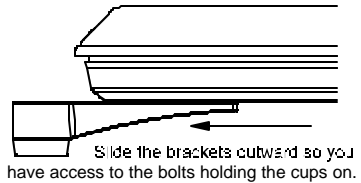
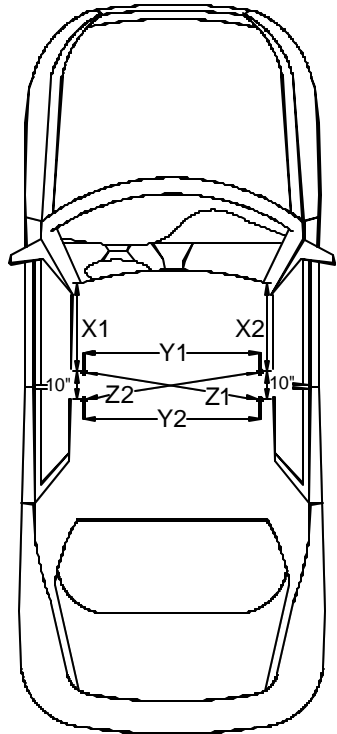

IMPORTANT

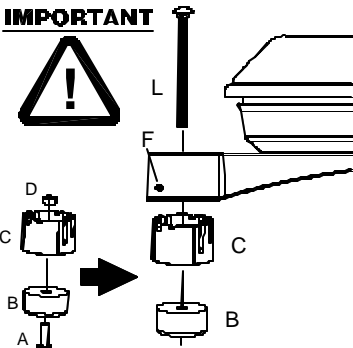

6. Remove the nut (D) and bolt (A) holding each rubber foot to the cup. Fasten the cup and rubber foot to the mounting bracket using the 3" carriage bolt (L). Repeat this for all four feet.
IMPORTANT: The 3" carriage bolt must pass through the mounting bracket, cup and foot. Please note: It will be necessary to remove the metal washer (not shown) inside of the rubber foot (B) so the carriage bolt (L) will fit through the foot. You may tighten the Allen head screw (F) to hold the cup in place temporarily.

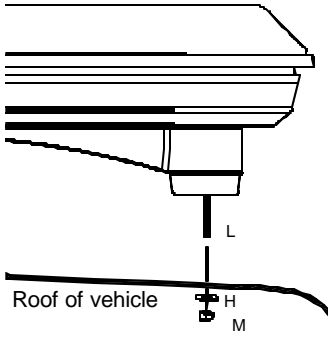

7. Mount the bar on the roof through the holes you drilled. Loosely install a flat washer (H) and the nut (M) to each bolt (*shown to the left*), but **DO NOT tighten them yet**. You need to leave them loose enough to lift the bar to gain access to the bolts securing the brackets to the lightbar.

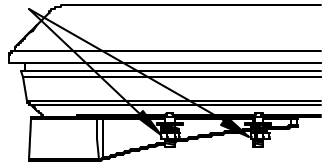

8. **Before tightening everything down**, from the front of the vehicle, check that the bar is centered from side to side. Once it is positioned satisfactorily, tighten the eight nuts which secure the mounting brackets to the bar itself, **leaving the four bolts through the roof loose**.

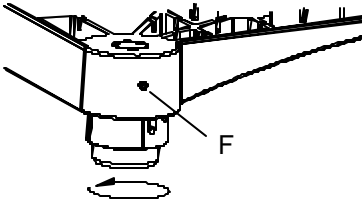

9. Once both mounts are secure to the lightbar itself, you may set the bar to the desired height. Slightly loosen the Allen head screws (F) holding each foot in place.

10. Lift each corner of the lightbar and rotate each individual foot until the lightbar is at the desired height. There are five different height settings for each leg. Repeat this for all four feet.

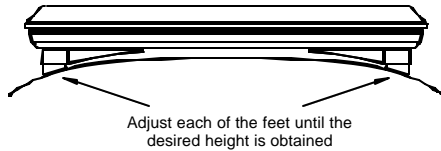

11. After you have adjusted each of the four feet to the desired height, check to see that the lightbar is level both side-to-side and front-to-back then tighten the Allen head screws. **Do not over-tighten any of the Allen head screws!**

12. Once the Allen head screws are tightened and you have double-checked that the bar is level and at the desired height, you may tighten each of the locknuts (M) on the carriage bolts (L).

13. The rubber feet will provide a barrier that separates the hard plastic leg from the metal of the roof. It helps to absorb any excess vibration and provides a barrier against any leakage. You may need to seal the holes with RTV (not included) if the rubber feet do not make a good enough seal with the roof of your vehicle.

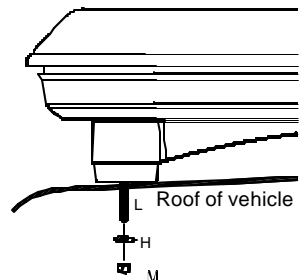

14. The mounting is complete and you may wire your lightbar.

WIRING INSTRUCTIONS

All standard models are designed for 12 VDC negative ground vehicles only. Reverse polarity will cause serious damage to the lightbar and/or vehicle. Contact the automotive dealer if there are any doubts about the polarity of your vehicle. A 12 VDC positive ground lightbar can be custom ordered, and it will be clearly labeled as such.

1. For quick and easy installation, 15 feet of wire is supplied standard with all models. All wires are color coded and sized at the correct gauge. If this length is not sufficient, it is recommended that wire connections be made directly at the terminal block inside the lightbar in order to reduce the number of wire connections and to avoid any weathering problems on these connections. Refer to the Direct Wiring Guide on page 10 for further instructions on this.
2. **CAUTION: All wires should be rated for at least 125% of their maximum current load. All wires connected to the positive terminal of the battery should be fused at the battery for their rated load.** The load can be calculated by adding all lamp wattages and dividing by 13. Load (Amps) = Total Watts / 13 volts. Do not use 1/4" diameter glass fuses, as they are not suitable for continuous duty above 20 amps. A table of recommended wire colors and wire sizes is provided below.
TESTING THE SYSTEM BEFORE IT IS PROPERLY FUSED & INSTALLED WILL VOID THE WARRANTY.
3. The black ground wire should be connected to a good chassis ground on the vehicle. This wire should be at least #10 AWG wire and be as short as possible in order to minimize the voltage loss in this wire and reduce any chance of overheating.
4. Using the Wire Usage Table below, connect the necessary wires to your switch panel (not supplied), ensuring that your switches are capable of handling the current draw necessary. Follow the instructions on the following page for details on how to connect the wires on lightbars utilizing remote strobe power supplies.

Wire Usage Table

LIGHT(S)	WIRE COLOR	Minimum AWG
Neutral/Ground/-12 VDC	Black	10
Rotating Halogen Lights	Orange	14
Alternate Rotating Halogen Lights	Orange w/Black Stripe	14
360° Strobe or Strobe Power Pack	Red	14
Strobe Pack Pattern Select	Red w/Green Stripe	22
Strobe Pack On/Off Heads #1 & #3	White w/Green Stripe	22
Strobe Pack On/Off Heads #2 & #4	Black w/Green Stripe	22
Alternate Strobe Pack PWR	Red w/Black Stripe	14
Starblast™ LED Heads	Orange w/Red Stripe	18
LED Optional Flash Pattern	Purple	18
Front Take-Down/Work Lights	Green w/Yellow Stripe	14
Front Alternating Flashers	White w/Brown Stripe	16
Rear Floods/Work Lights	White w/Orange Stripe	14
Rear Alternating Flashers	White	16
Intersection Clearing Lights	White w/Blue Stripe	16
Left Alley Light	Blue	16
Right Alley Light	Gray	16
Left Turn Signal	Yellow	16
Right Turn Signal	Green	16
Tail Lights & ID Marker Lights	Brown	18
Alternate Power	Red w/White Stripe	14
LED Traffic Director	†	†
Star Stik™ Incandescent Traffic Director	†	†
+ Side to Siren (Red on Siren)	Pink	18
- Side to Siren (Black on Siren)	Pink w/White Stripe	18

† Separate Bundled 9-Conductor Cable

5. The Wire Usage Table lists wire colors and standard functions controlled by those wires. Your wiring harness may contain extra wires that are not utilized in your bar. These wires will be connected to the terminal block inside your lightbar, but there will be no wires connected to the terminal across from them. They can be used for additional components that may be added at some point in the future, or they may be used to separately switch components currently wired together.
6. Since many of the lightbars we build have custom components, occasionally wire colors may slightly vary. If you are unsure of the function of a particular wire, you may test the function by grounding the black wire and applying +12VDC to the wire in question. Be sure to use a 20-amp fuse when testing.

The correct wire size and color listed in the table on the previous page corresponds directly with the wiring of the lightbar. All switches used should be rated for the maximum current load applied. Current load can be determined by adding all lamp wattages powered through the switch and dividing by 13. If you are unsure of the current draw please contact our Customer Service Department. Since switches rated for a very high continuous current are not very common, lightbars with high current draw may contain two wires of the same color exiting the base of the bar. If the switch being used is rated for a high enough current, these wires may be connected together and run through the same switch. Otherwise either two separate switches or one switch with two separate poles should be used.

Remote Strobe Power Supply Connections

If your lightbar contains a remote strobe power supply, follow the instructions below for proper wiring.

Four wires in your cable harness control the strobe heads and strobe power supply: Red, Red w/Green Stripe, White w/Green Stripe, and Black w/Green Stripe. The functions of those wires are as follows:

- Red** - Power to the strobe power supply
- Red w/Green Stripe** - Pattern Select
- White w/Green Stripe** - On/Off control for Heads #1 alternating w/ #3
- Black w/Green Stripe** - On/Off control for Heads #2 alternating w/ #4

Note: *If you have power to both White w/Green and Black w/Green #1 & #2 will alternate with #3 & #4. For two outlet packs, the two heads will alternate.*

Activating All Strobe Heads Together (MOST APPLICATIONS)

To turn on all four heads connected to the power supply together, connect the Red, White w/Green Stripe, and Black w/Green Stripe together through your switch. When the switch is thrown, all of your strobes will flash. (#1 & #2 will alternate with #3 & #4)

Activating the Front and Rear Strobes Separately

If you would like the ability to switch the Front Strobes On/Off separate from the Rear Strobes, connect the White w/Green Stripe wire to one switch and the Black w/Green Stripe wire to another switch. The Red wire must be connected to constant +12VDC. **Please**

Note: *When the red wire is connected to +12VDC the pack will draw a small current (50 mA). If your vehicle will be sitting for extended periods of time (i.e. more than a few days), it is recommended this wire be routed through a switch.*

Pattern Selection

The Red w/Green Stripe wire allows you to select the flash pattern you wish to have your bar operate with. The pack is defaulted for Five-Flash mode. You can scroll through Pseudo-Random, Off, Singleflash, Doubleflash, Quadflash, and back to Five-Flash by turning your strobe lights on and briefly touching the Red w/Green stripe wire to +12VDC and releasing it. Continue to briefly touch and release this wire to +12VDC until you find the pattern desired. Once you have the pattern you like, tape the end of the Red w/Green Stripe wire so that it does not come into contact with +12VDC.

Automatic Power Up Head Check

Your new power pack comes with a safety feature which checks for proper operation of each individual strobe head each time you turn on the strobe pack. This feature works by quickly flashing each head once separately and determining if any of the heads did not flash. If two heads normally flash together and one should fail and does not flash during the start up test, the strobe pack will automatically reduce the output power to that particular side so that the “other” remaining head(s) isn’t over powered. The power to that side will be cut in half until the strobe pack is turned off and on again.

The strobe pack will check all of the heads each time the pack is turned on EVEN if the head select feature is being used and only two heads are to be activated. After checking all of the heads, the pack will begin flashing normally. It takes approximately 0.250 sec. to check all of the heads.

Note: *If you replace the non-working head, it is necessary to cycle power to the pack before that head and the one that flashes with it will start flashing again at full power.*

Direct Wiring Guide

(When more than the supplied 15 ft of cable are needed, follow these instructions to remove the pre-installed cable and install your own.)

Star recommends direct wiring to the terminal block on the inside of the lightbar if the wire supplied is too short, rather than making connections to the end of the wire which is supplied. This lightbar is designed so that no wire connectors are needed and only a few common tools are necessary in order to do this. Direct wiring allows the wire connections to the lightbar to be made in a clean and dry environment, avoiding any problems that may arise due to weathering on external connections. There is also an increase in voltage loss with the addition of each connection. Wiring directly inside the lightbar reduces the number of connections. However, making connections to the wires already provided is an acceptable alternative, as long as these connections are good electrical connections and are resistant from weathering effects. For direct wiring into the lightbar, follow the instructions listed below.

1. Determine the number of wires that you will need to run. This can be done by counting the number of wires coming out of your lightbar.
2. Using the Wire Usage Table shown on page 8, identify your wires and select appropriate wire sizes and colors.
3. Locate the end of the lightbar that has the external wires entering the base of the lightbar. The black terminal block(s), which you will be making your wire terminations to, should also be located at this same end.
4. Remove the dome lens at this end of the lightbar:

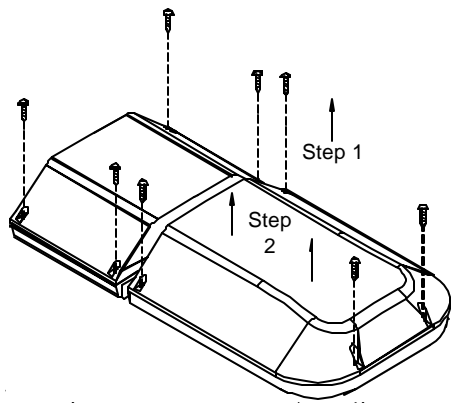

- Step 1 :** Loosen the four screws holding each dome on.
- Step 2 :** Lift the dome off of the base exposing the interior components.
- Step 3 :** When all work is completed, reverse that the gasket is properly aligned.
5. All of the wires coming from outside of the lightbar are terminated on the same side of the terminal block and the wires leading to the internal components terminate on the opposite side of the terminal block. Loosen the screws on the terminal block and remove **only those wires that exit the lightbar through the hole in the base.**

6. Run the new external wires up through the wire bushing into the base and into the terminal block(s). The function of each color wire in the lightbar is listed in the Wire Usage Table on page 8.
7. Align each external wire on the terminal block directly across from the corresponding internal wire with the same function. If there is more than one internal wire of the same color connected to the terminal block, align the external wire across from any one of that same color wire. Electrically, the same color wires are all connected.
8. Strip each wire 1/4". Connect the external wires to the proper poles of the terminal block by inserting the stripped portion of the wire under the rising clamp screw and tightening down the screw. **No** wire terminals are needed for connecting wires to this terminal block. **Be sure to check that no strands of wire are loose and shorting to the adjacent terminal or to the base of the lightbar.**

INTERCEPTOR

Parts List

Bulbs and Tubes

Upper Level

4.5" Linear Strobe Tube	LST129-4
7" Linear Strobe Tube	LST129-7
360° Strobe Head	ST3901-7
50-Watt Halogen Bulb	2073-795
<i>(For Rotators and Takedowns)</i>	
Stop-Turn-Tail Bulb	2073-1157

Lower Level

27-Watt Halogen Bulb	2073-H27
<i>(For Alley, ICL, Flashers, Pursuit and Takedowns)</i>	

Directional Arrow Incandescent Bulb 2073-94

Stop-Turn-Tail Bulb	2073-1157
Strobe Tube for ICL	ST3901-12

Domes, Filters, and Lenses

Upper Level

End Dome	820-21-*
Center Dome	820-22-*
Rotator Filter	920-100-*
Low Profile Stationary Filter	820-100LL-*
<i>(Worklights, Takedowns, Flashers, etc.)</i>	
4.5" Linear Strobe Filter	LSF4.5-5-*
7" Linear Strobe Filter	LSF7-5-*
Dome for 360° Strobe Head	333-*

Lower Level

LL End Dome	820-21L-*
Center Dome	820-22L-*
Lower Level Filter	820-100LL-*
<i>(Worklights, Takedowns, Flashers, ICL's, Arrowstick, etc.)</i>	

Mounting Brackets

Permanent Mount	820-39-P*
Magnetic Mount	177-BK
Hook Mounts	

These are pictured on page 12 and work in conjunction with the 820-39-P*

Power Supplies/Flashers

ICL Single Head Strobe P.S.	RP310-ICL
2-Head Strobe Power Supply	RP248A
4-Head Strobe Power Supply	RP248
Standard (1.9FPS) Flasher	FM3661
High-Speed (2.9FPS) Flasher	FM3662
LED Flasher	LDF399

Miscellaneous Interior Components

Upper Level

4.5" Linear Strobe Head (less tube)	SH3964
7" Linear Strobe Head (less tube)	SH3967
Starblast™ LED Head	LDH3966-*
Rotator (95FPM)	920-99
High-Speed Rotator (150FPM)	920-99F
DH/Worklight/Takedown	920-51
Medium "V" Mirror	820-29
Large "V" Mirror	920-29
Wall Mirror	920-30
Multi-Faced Lightning Mirror	820-2†
ID/Marker Light w/Bracket	920-38
ID/Marker Light Bracket	920-36
Stop, Turn, Tail	920-32

Lower Level

ICL, DH, Flasher, TD/P, Alley, Work	820-14
Strobe Intersection Clearing Light	820-14SH
Stop, Turn, Tail	820-14STT
Directional Arrow Light	820-14LDA
Single 18-LED Array	820-14D1
Double 18-LED Array	820-14D2
Triple 18-LED Array	820-14D3





* = color (A,B,C,G, or R)

† = Specify Left or Right (L or R)

Screws and Bolts

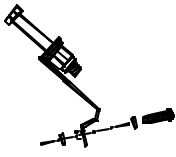
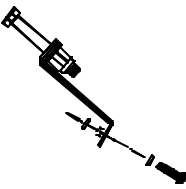
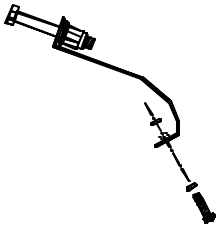
Top Dome Screws	30053-33
Threaded Nut Insert	300168-7
Gasketing (1 foot)	30047-61

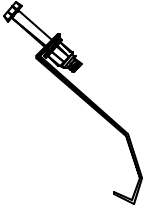
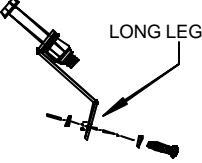
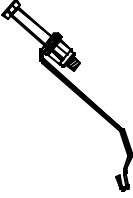
Hook Mounts

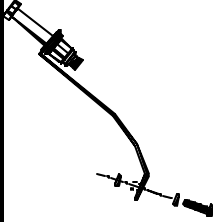
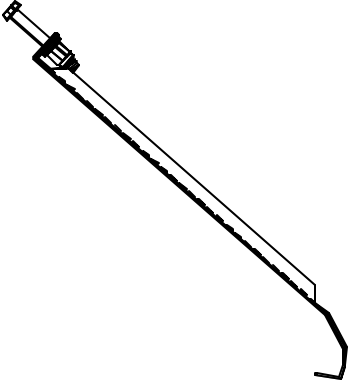
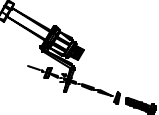
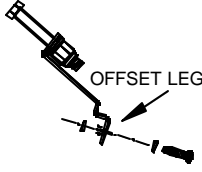
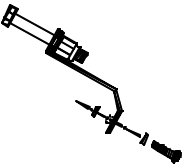
<p>920-35C</p> 	<p>920-35CVLP</p> 	<p>920-35F</p> 	<p>920-35I</p> 
<p>920-35C5</p> 	<p>920-35CTB</p> 	<p>920-35GM</p> 	<p>920-35INT</p> 
<p>920-35</p> 	<p>920-35RAM2</p> 	<p>920-35IZ</p> 	
<p>920-35EX</p> 	<p>920-35-S105</p> 		
<p>920-35D</p> 			

8/26/04

Hook Mount Applications

Make	Model	YEAR	MOUNT
CHEVROLET	C/K Pick Up	1999-2004	920-35-
CHEVROLET	C/K Pick Up 2500 3500	2001-2004	920-35- S105
CHEVROLET	Camaro	1984-1992	920-35
CHEVROLET	Caprice	1988-	920-35C5
CHEVROLET	Caprice	1988-1994	920-35C
CHEVROLET	Caprice	1977-1990	920-35
CHEVROLET	Cavalier Z-24	1990-1994	920-35
CHEVROLET	Impala	2000-2004	920-35I
CHEVROLET	Lumina	1997	920-35GM
CHEVROLET	Lumina	1998	920-35C
CHEVROLET	R/V Chassis-Cab	1990-1991	920-35
CHEVROLET	R/V Series	1990-1991	920-35
CHEVROLET	S-10	1995	920-35-
CHEVROLET	Suburban	2000-2004	920-35-
CHEVROLET	Suburban	1990-1991	920-35
CHEVROLET	Tahoe	200-2004	920-35-
CHEVROLET	Tahoe	???	920-35-
CHEVROLET	Trailblazer	2002-2004	920-35CTB
CHEVROLET	Trucks	1980-1987	920-35C5
CHEVROLET	Trucks	1988-1994	920-35GM
CHEVROLET	Van (Cargo)	1999	920-35C
CHEVROLET	Van (not Astro)	1988-1995	920-35
DODGE	Caravan/Grand Caravan	???	920-35C
DODGE	Dakota	1997-2004	920-35GM
DODGE	Durango	1996-2004	920-35GM
DODGE	Durango	2004	920-35-
DODGE	Full Size Vans	1989	920-35
DODGE	Intrepid	1996	920-35INT
DODGE	Intrepid	1998-2004	920-35GM
DODGE	Intrepid	1999-2004	920-35F
DODGE	Ram	1991	920-35
DODGE	Ram	1995	920-35C
DODGE	Ram	1995-1998	920-35-
DODGE	Ram	1999-2001	920-35D
DODGE	Ram (Quad cab)	1999-2001	920-35GM
DODGE	Ram pickup (2-Wrap Around Doors)	1994-1998	920-35CTB
DODGE	Ram pickup	1994-1998	920-35F
DODGE	Ram pickup	2003-2004	920-35RAM2

Make	Model	YEAR	MOUNT
FORD	Bronco	1995	920-35F
FORD	Crown Victoria	1988-1994	920-35C5
FORD	Crown Victoria	2000-2004	920-
FORD	E-Series(Van)	1987-2004	920-35
FORD	Excursion	2000-2004	920-35GM
FORD	Expedition	1997	920-35EX
FORD	Expedition	2003	920-35EX
FORD	Expedition	2004	920-35F
FORD	Explorer	2000	920-35
FORD	Explorer	2000-2004	920-35D
FORD	F-250	1991	920-35C
FORD	F-250	1991	920-35C5
FORD	F-350	2000	920-35
FORD	F-Series	1987-1996	920-35
FORD	F-Series	1988-1995	920-35F
FORD	F-Series	1997	920-35D
FORD	F-Series	1998-2001	920-35D
FORD	F-Series	1998-2004	920-35GM
FORD	F-Series (250, 350, 450, 550)	1998-2004	920-35GM
FORD	LTD-Crown Vic	1988-1991	920-35
FORD	LTD-Crown Vic	1992-2004	920-CVLP
FORD	Mustang	1988-1993	920-35
FORD	Ranger	1987- 1997 1997	920-35
FORD	Ranger	1999-2000	920-35GM
FORD	Ranger	2002-2004	920-35GM
FORD	Windstar	1999-2001	920-35GM
GMC	Envoy	2002-2004	920-35CTB
GMC	GMC Truck	1988-1994	920-35GM
GMC	GMC Truck	1995-2000	920-35-
GMC	Jimmy (full size)	1990-1991	920-35
ISUZU	Heavy Duty Truck Chassis	1998-2004	920-35IZ
JEEP	Jeep Cherokee	1990-1994	920-35
JEEP	Jeep Cherokee	1995-2001	920-35
JEEP	Jeep Cherokee	1995-2001	920-35GM
JEEP	Jeep Grand Cherokee	1999-2004	920-35GM
JEEP	Jeep Liberty	2002-2004	920-35GM
PLYMOUTH	PT Cruiser	2000-2004	920-35GM
PONTIAC	Grand Prix	1994	920-35GM

SWITCH PANELS AND SWITCH BRACKETS

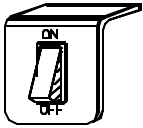

SP3860-1

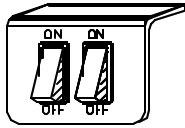

SP3860-2

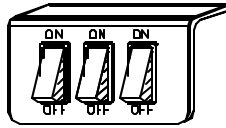

SP3860-3

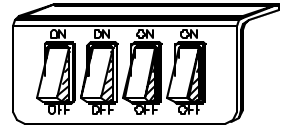

SP3860-4

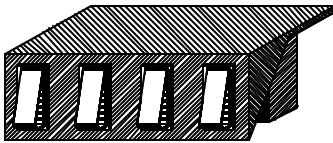

SP1515

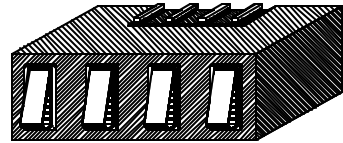

SB1515

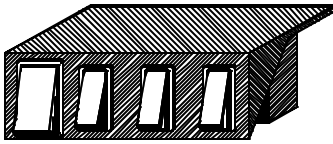

SP3015

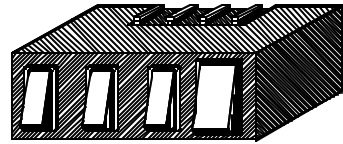

SB3015

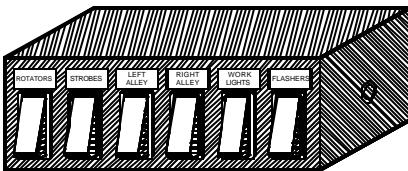

SB4020

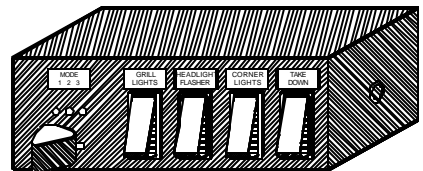

SB4040



CAUTION: High voltages exist in electronic strobe lights. Before attempting service on any strobe light, be sure to disconnect the power for at least five minutes to allow the capacitor to discharge. Failure to heed this warning may result in severe electrical shock and/or injury.

Please Note: Most strobe and rotating beacon failures can be traced to wiring and battery problems. Before attempting any service on the circuit itself, please be sure to check all connections and wiring to ensure the correct voltage and/or polarity is reaching your light or remote head.

Troubleshooting Guide

*If a light on your bar fails to work, please refer to this section to help solve your problem. If you still cannot resolve your problem, please contact our **Customer Service Department** at 585-226-9787.*

The chart below contains some basic guidelines for troubleshooting any problems you may experience with your bar. The section following the chart will explain in further detail how to perform some of the troubleshooting tasks.

<u>Symptom:</u>	<u>Possible Solutions</u>
One rotator spins but won't light up	Check bulb
One rotator does not spin and does not light up	Check the power wire running between the rotator and the terminal block Check the ground wire on the rotator
More than one rotator does not spin and does not light up	Check power to terminal block Check the ground
One single LED light is Out	LED Head needs to be replaced
One LED head does not flash	Check wiring between LED head and flasher unit Check LED head
Multiple LED heads not flashing	Check power to terminal block Check that the bar is properly grounded Check power from terminal block to LED flasher unit Check that the LED flasher unit is grounded properly
One flashing light out	Check bulb Check power wire from flasher unit to bulb Check that the bulb is grounded
Multiple flashing lights out	Check power to terminal block Check that the bar is properly grounded Check power from terminal block to flasher unit Check that the flasher unit is grounded properly
One remote strobe head out	Check the strobe head Check the cable from the remote pack to the strobe head
Multiple strobe heads out	Check power to terminal block Check power to strobe pack Power Outlet (PWR) Check power to strobe pack Control Outlet (CTRL) Check that the pack is properly grounded

If components on your lightbar are not operating follow these steps to determine the problem:

Check all fuses, including those at the battery, at the switch panel, in the dash, and on the pack (if applicable). The RP248 and RP248A strobe power supplies both have automotive "blade" type fuses. Remove these fuses, and check them to confirm they have not blown. Replace any blown fuses with only fuses of identical values. Replacing the fuse with the wrong rating may damage your power supply and/or vehicle, and will void your warranty.

Determining if the bar is properly grounded:

1. While the bar is turned on, using a test meter, measure the voltage from the base of the bar itself to the negative post of the battery or a good chassis ground if the battery can't be easily reached. You may need to scrape away a bit of anodizing or paint in order to ensure a good connection with the probe of your test meter.

2. If the difference shown is greater than .25 volts, then your ground is not sufficient.
3. If the ground is insufficient, locate the ground wire connection in your lightbar by removing the dome over the section where the wires enter the bar. Please follow the appropriate dome removal instructions listed earlier in this manual when removing this dome. The ground wire is the large (10AWG) black wire attached to the inside of the lightbar base with a ring terminal. Check the integrity of the connection of the ground wire to both the lightbar base and at the other end to a good chassis ground.
4. While inspecting the ground wire connections you should also check that the wire itself is not damaged. Carefully inspect the wire along its entire length, paying special attention to those areas where the wire passes through any holes that may have sharp edges that can damage the wire and the areas where the wire makes any sharp bends.

Checking the power to the terminal block

(Determining if the proper voltage is reaching your bar):

1. Locate the terminal block in your lightbar. After entering the bar, the wires will be connected to the terminal block with a number of small Phillips head screws.
2. With the bar turned on, use a test meter to test the voltage at the terminal block. A nominal 12.5 volts should be present on all of the wires you have connected to power at the other end of the harness. Low voltage can cause erratic flashing in strobe heads or even complete failure of the heads. A minimum of 9.5 volts should be present for the pack to operate properly. Low voltage in rotating lights, flashing light, or LED can result in lowered intensity or even complete failure.
3. Be sure to test each wire that comes into the terminal block for proper voltage.
4. Carefully inspect each wire in the terminal block. Check that the ends of the wires have not frayed and shorted against one another or against the base. This may cause lights to operate inadvertently or may result in the failure of lights.

Checking one non-working halogen or incandescent light:

If a problem exists in only one light, a bulb may have burned out or there may be an open electrical connection in the wiring harness.

1. Check connections at and between the flasher unit or terminal block and the faulty light, including all wiring. If your wiring is fine, continue below.
3. Check the faulty bulb by swapping it with one that is working. If the faulty bulb still does not work, then the bulb is bad and will need to be replaced.
4. If the bulb that was not lighting before now works in the new socket, the problem probably lies in the flasher itself. Verify this by plugging the other bulb (the original working bulb you just unplugged) into the socket that previously had the non-working bulb.
5. If the problem is not with a bad bulb and if proper voltage is reaching the flasher unit, the problem is most likely internal to the flasher unit.

Checking one non-working strobe head:

If a problem exists in only one head, a strobe tube may have burned out, or there may be an open electrical connection in the wiring harness or strobe head.

1. Check connections at and between the strobe pack and the faulty strobe head, including all wiring.
2. Unplug both the faulty strobe head and a working strobe head.
3. Check the faulty head by plugging it into the outlet you just unplugged the working head from. If the faulty head still does not work, then the head is bad and will need to be replaced.
4. If the head that was not flashing now works in the new outlet, the problem probably lies in the power pack. Verify this by plugging the other head (the original working head you just unplugged) into the outlet that previously had the non-working head.

Checking multiple non-working strobe heads:

If the problem exists in only your strobe heads, and none of your strobe heads are flashing, follow these steps to determine the problem:

1. **Check all fuses**, including those at the battery, at the switch panel, in the dash, and on the pack (if applicable). The RP248 and RP248A power supplies all have automotive "blade" type fuses. Remove these fuses, and check them to confirm they have not blown. Replace any blown fuses with only fuses of identical values. Replacing the fuse with the wrong rating may damage your pack and/or vehicle, and will void your warranty.
2. **Check the power and ground wires to your pack.** With the vehicle turned off and while the pack is running, measure the voltage across the red wire (pin 1) and the black wire (pin 2) of the **PWR** connector on the power pack (the one with the Red, Black, and Purple wires). Push the probes of the test meter down into the connector at the wire entry points to contact the terminals for the measurement. A nominal 12.5 volts should be present. Low voltage to the pack can cause erratic flashing or even complete failure of the heads. A minimum of 9.5 volts should be present for the pack to operate properly. If you do not have proper voltage present, your power or ground is bad. Continue on to step 5.
If your pack is receiving sufficient voltage then skip to step 4.
3. **Test the Power to the power supply from the terminal block.** If sufficient voltage is not reaching the pack and you have already determined that proper voltage is reaching your terminal block, perform the following tests: With the vehicle turned off and while the pack is running, measure the voltage drop in the red wire by taking a reading from pin 1 of your Power connector (Red wire) and the corresponding wire on the terminal block. If this reading exceeds 0.25 volts then there is a poor connection between the terminal block and your power supply in the red wire and it should be checked.
4. **Check the Ground wire on the pack.** If you still have not located the problem, troubleshoot the connections between pin 2 (black wire) of the **PWR** connector on the power pack and the lightbar base, while the lightbar is running. If this reading exceeds 0.25 volts then there is a poor connection between the pack and the lightbar base in the black wire and it should be checked.
5. **Check that the proper voltage is reaching the necessary CTRL inputs.** Check that the proper voltage is reaching the Black wire (across from the Black w/Green stripe wire) and White wire (across from the White w/Green stripe wire) of the **CTRL** plug on your strobe pack with the vehicle turned off and while the bar is running. Measure the voltage across the Black wire (pin 2) on the CTRL plug (**NOT THE POWER PLUG**) and a good chassis ground. Push the probes of the test meter down into the connector at the wire entry points on the pack side of the connectors to contact the terminals for the measurement. Note this reading. A nominal 12.5 volts should be present. A minimum of 9.5 volts should be present for the pack to operate properly. Also check the voltage on the White wire. If your pack is receiving sufficient voltage to both wires then continue to step 6. If you do not have proper voltage on either wire present check the wiring to the connector.
6. **Check the CTRL connector to be sure that +12VDC is not applied the Red wire.** The Red wire is used for pattern select. The patterns are changed by touching AND **RELEASING** this wire to +12VDC. A constant voltage applied to the Red wire on the CTRL connector will prevent the strobe pack from flashing.
7. **Check each strobe head.** If the leads in one of the heads have shorted out, the output voltage of the other heads may be held down as well. To test for this, unplug all of the heads and plug them in individually, one at a time. If your problem is a result of a shorted head, then the other heads should function properly if the faulty head is no longer connected. Note: A burned out strobe tube does not cause a short and will not affect the operation of the remaining heads. If the problem is not with a shorted head and if proper voltage is reaching the pack, the problem is most likely internal to the pack.

ONE YEAR LIMITED WARRANTY

The manufacturer warrants each new product, under normal use, against factory defects in material and workmanship for one year after the date of purchase. The owner will be responsible for returning to the Service Center any defective item(s) with the transportation costs prepaid. The manufacturer will, without charge, **repair or replace at its option**, products, or part(s), which its inspection determines to be defective. Repaired or replacement item(s) will be returned to the purchaser with transportation costs prepaid from the service point. A copy of the purchaser's receipt must be returned with the defective item(s) in order to qualify for the warranty coverage.

Exclusions from this warranty include, but are not limited to, bulbs, strobe tubes, domes, and/or the finish. This warranty shall not apply to any light, which has been altered, such that in the manufacturer's judgment, the performance or reliability has been affected, or if any damage has resulted from abnormal use or service. This warranty does not apply to defect or damage occurring as a result of disaster, accident, abuse, misuse, lightning, power surges, or failure to follow instructions in any enclosed manuals. Any damage or defects occurring as a result of any unauthorized service or repairs by unauthorized persons shall be excluded from this warranty.

There are no warranties expressed or implied (including any warranty of merchantability or fitness), which extend this warranty period. **The loss of use of the product, loss of time, inconvenience, commercial loss or consequential damages, including costs of any labor, are not covered.** The manufacturer reserves the right to change the design of the product without assuming any obligation to modify any product previously manufactured.

If you have any questions concerning this or any other Star product, please contact our **Customer Service Department** at (585) 226-9787.

If a product must be returned for any reason, please contact our Customer Service Department to obtain a Returned Goods Authorization number (RGA #) before you ship the product to Star.

Please write the RGA # clearly on the package near the mailing label.



Star Headlight & Lantern Co., Inc.

455 Rochester Street
Avon, NY 14414

www.star1889.com



Phone: 585-226-9500

Fax: 888-478-2797

www.star1889.com

